



disano
illuminazione



Swimming pool lighting

A selection of **chemically resistant** lighting fixtures
for environments with high chlorine content.

M A D E I N I T A L Y

Chemical compatibility in LED lighting fixtures for environments with the presence of chlorine

Criticalities may occur when installing LEDs in environments with high concentrations of particular types of chemicals.

Two things can damage or shorten the lifespan of LEDs:

- electrical stress
- chemical incompatibility.

Chemical incompatibility is a process that occurs within the LED caused by external contaminants.

Not all LEDs are subject to corrosion.

The products selected by Disano for these types of environments use:

- **LED Mid Power** sources that, in order to resist to chlorine gas, requires the application of a [conformal coating treatment](#). In this case, the LED is protected against heat exchanges, it will not be negatively affected by chemical gases and it will not degrade under UV radiation, making the LED Mid Power last longer. This treatment will keep both luminous flux and colour temperature unaltered.
- **LED High Power** sources, [already recommended](#) for environments with high concentrations of chlorine gas, do not require any special coating treatment.





N.B.: at present, **COB* LED** sources are [not protected](#) against chlorine and they cannot be subjected to conformal coating treatment. As a result, they can darken and damage, including degradation of luminance and luminous flux and variation of their colour temperature.

*= COB (chip on board) LEDs are multiple LED chips bonded directly to a substrate to form a single module.

Disano has developed a series of luminaires especially suited for installation in swimming pools and environments containing chlorine gas.

Also, the application of the coating cycle makes these fixtures long lasting also in terms of lighting levels, stability and visual appearance.



Rodio - Mid Power - with conformal coating treatment			
	Rodio	from page	4
	Rodio HP		
Cripto - High Power			
	Cripto Small	from page	10
	Cripto Medium		
	Cripto Big		
Astro - High Power			
	suspension	from page	16
	floodlight		
Forum - High Power			
	1 module	from page	20
Hydro Style - Mid Power			
		from page	22

Rodio asymmetric



IP66IK08

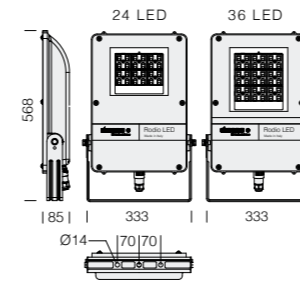

Optics: in high performance PMMA with conformal coating treatment.

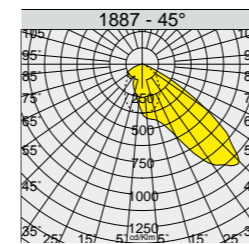

IP66IK08

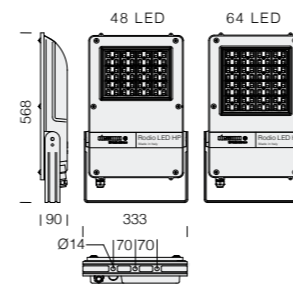

Optics: in high performance PMMA with conformal coating treatment.

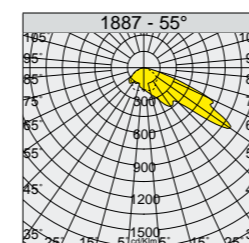

24 LED



36 LED

53W-79W-118W=<4%
157W=8%
LOW FLICKER

53W-79W-118W=
6/8kV
157W=4/8kV
SURGE

RG0
E_{th}

+40
C°
-20

80.000h
L80B20

4000K

CRI
80

1887 Rodio - asymmetric					
		CLD CELL		LUMEN OUTPUT (tq= 25 °C)	
wattage	colour	weight	code	W tot	K - ølm - CRI - degrees
24 LED	graphite	6.30	414754-38	53	4000K - 6874lm - CRI 80 - 45°
24 LED	graphite	6.30	414755-38	79	4000K - 9210lm - CRI 80 - 45°
36 LED	graphite	6.30	414756-38	118	4000K - 13488lm - CRI 80 - 45°
			414752-38		4000K - 13392lm - CRI 80 - 55°
36 LED	graphite	6.30	414757-38	157	4000K - 16843lm - CRI 80 - 45°
			414753-38		4000K - 16424lm - CRI 80 - 55°



48 LED



64 LED

211W-284W=≤8%
LOW FLICKER

211W-284W=
4/8kV
SURGE

RG0
E_{th}

+40
C°
-20

80.000h
L80B20

4000K

CRI
80

1887 Rodio HP - asymmetric					
		CLD CELL		LUMEN OUTPUT (tq= 25 °C)	
wattage	colour	weight	code	W tot	K - ølm - CRI - degrees
48 LED	graphite	8.00	414758-38	211	4000K - 25500lm - CRI 80 - 45°
			414761-38		4000K - 25320lm - CRI 80 - 55°
64 LED	graphite	9.60	414759-38	284	4000K - 34620lm - CRI 80 - 45°
			414762-38		4000K - 33760lm - CRI 80 - 55°

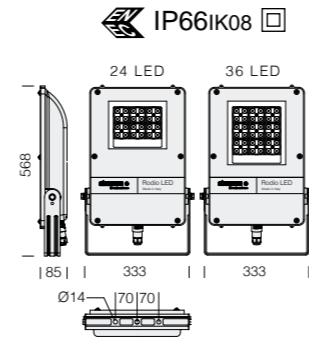

Optics: in high performance PMMA with conformal coating treatment.

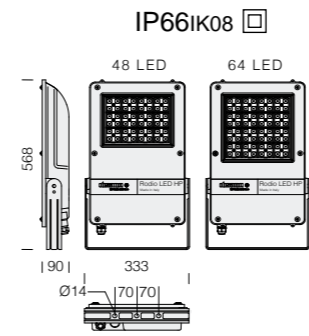
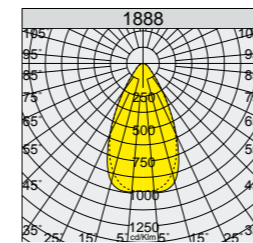

Optics: in high performance PMMA with conformal coating treatment.

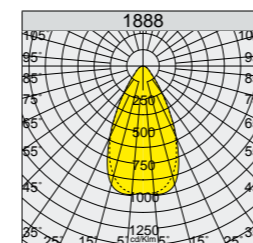

53W-79W-118W=<4%
157W=8% **LOW FLICKER**

53W-79W-118W=
6/8kV
157W=4/8kV **SURGE**

RG0
E_{th}

+40
C°
-20

80.000h
L80B20

4000K

CRI
80

1888 Rodio - symmetric narrow beam					
wattage	colour	weight	CLD CELL		LUMEN OUTPUT (tq= 25 °C)
			code	W tot	K - ølm - CRI
24 LED	graphite	6.30	414764-38	53	4000K - 6830lm - CRI 80
			414765-38	79	4000K - 9152lm - CRI 80
36 LED	graphite	6.30	414766-38	118	4000K - 13362lm - CRI 80
			414767-38	157	4000K - 16735lm - CRI 80



211W-284W=<8% **LOW FLICKER**

211W-284W=
4/8kV **SURGE**

RG0
E_{th}

+40
C°
-20

80.000h
L80B20

4000K

CRI
80

1888 Rodio HP - symmetric narrow beam					
wattage	colour	weight	CLD CELL		LUMEN OUTPUT (tq= 25 °C)
			code	W tot	K - ølm - CRI
48 LED	graphite	8.00	414768-38	211	4000K - 25300lm - CRI 80
64 LED	graphite	9.60	414769-38	284	4000K - 35195lm - CRI 80

Rodio symmetric wide beam



IP66IK08

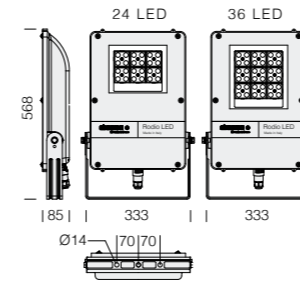

Optics: in high performance PMMA with conformal coating treatment.

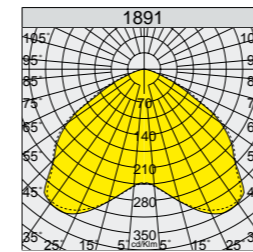

24 LED



36 LED

53W-79W-118W= $\leq 4\%$
157W=8%
LOW FLICKER

53W-79W-118W=
6/8kV
157W=4/8kV
SURGE

RG0
E_{tr}

+40
C°
-20

80,000h
L80B20

4000K

CRI
80

1891 Rodio - symmetric wide beam					
wattage	colour	weight	CLD CELL		LUMEN OUTPUT (tq= 25 °C)
			code	W tot	K - ølm - CRI
24 LED	graphite	6.30	414784-38	53	4000K - 6740lm - CRI 80
			414785-38	79	4000K - 9032lm - CRI 80
36 LED	graphite	6.30	414786-38	118	4000K - 13188lm - CRI 80
			414787-38	157	4000K - 16516lm - CRI 80

IP66IK08

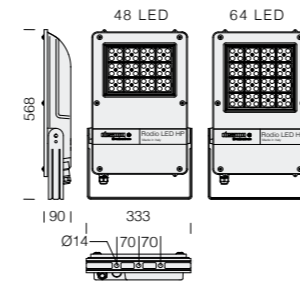

Optics: in high performance PMMA with conformal coating treatment.

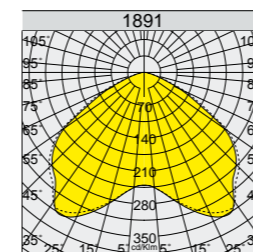

48 LED



64 LED

211W-284W= $\leq 8\%$
LOW FLICKER

211W-284W=
4/8kV
SURGE

RG0
E_{tr}

+40
C°
-20

80,000h
L80B20

4000K

CRI
80

1891 Rodio HP - symmetric wide beam					
wattage	colour	weight	CLD CELL		LUMEN OUTPUT (tq= 25 °C)
			code	W tot	K - ølm - CRI
48 LED	graphite	8.00	414788-38	211	4000K - 25890lm - CRI 80
64 LED	graphite	9.60	414789-38	284	4000K - 34570lm - CRI 80

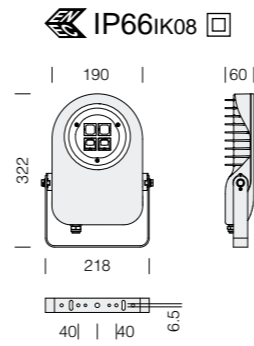

Optics: in PMMA, highly resistant to temperature and UV radiation. Flow recovery in V0 polycarbonate.

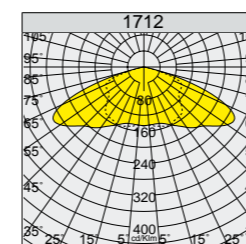
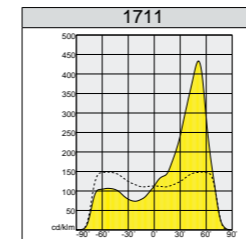

acc. 339 Connector
993836-00

To be used for mains connection of Cripto small.



35W=<5%
LOW FLICKER

35W=3,5/4kV
SURGE

RG0
Etr

+40
C°
-20

80.000h
L80B10

4000K

CRI
80

1711 Cripto small - asymmetric

wattage	colour	weight	CLD CELL		W tot	LUMEN OUTPUT (tq= 25 °C)	
			code	K - ølm - CRI			
4 LED	graphite	4.00	413010-00	35	4000K - 3293lm - CRI 80		
	grey 9006		413011-00				
	anthracite		413012-00				

1712 Cripto small - symmetric

wattage	colour	weight	CLD CELL		W tot	LUMEN OUTPUT (tq= 25 °C)	
			code	K - ølm - CRI			
4 LED	graphite	4.00	413020-00	35	4000K - 3483lm - CRI 80		
	grey 9006		413021-00				
	anthracite		413022-00				

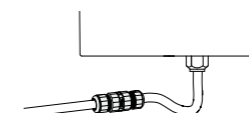

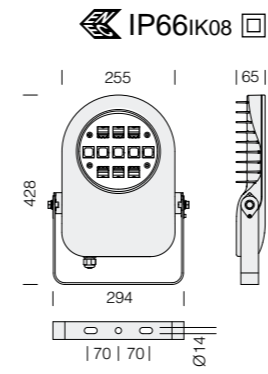

Optics: in PMMA, highly resistant to temperature and UV radiation. Flow recovery in V0 polycarbonate.

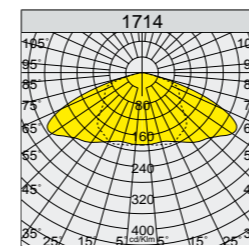
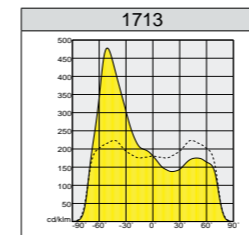

- 93W=5% **LOW FLICKER**
- 93W=4/6kV **SURGE**
- RG0 Etr**
- +40 C° -20
- 80.000h L80B10
- 4000K
- CRI 80

1713 Cripto medium - asymmetric

wattage	colour	weight	CLD CELL		W tot	LUMEN OUTPUT (tq= 25 °C)	
			code			K - ølm - CRI	
11 LED	graphite	5.50	413030-00	93	4000K - 9121lm - CRI 80		
	grey 9006		413031-00				

1714 Cripto medium - symmetric

wattage	colour	weight	CLD CELL		W tot	LUMEN OUTPUT (tq= 25 °C)	
			code			K - ølm - CRI	
11 LED	graphite	5.50	413040-00	93	4000K - 9583lm - CRI 80		
	grey 9006		413041-00				

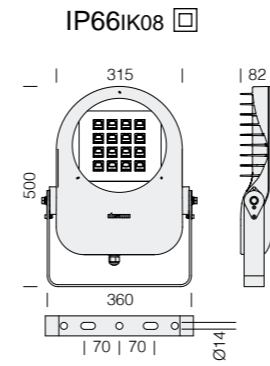

Optics: in PMMA, highly resistant to temperature and UV radiation. Flow recovery in V0 polycarbonate.

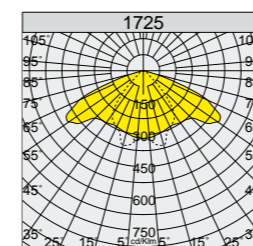
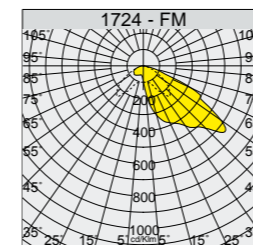
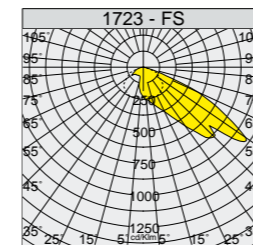

- 134W=1% LOW FLICKER
- 134W=6/8kV SURGE
- RG0 Etr
- +30 C° -30
- 80,000h L80B10
- 4000K
- CRI 80

1723 Cripto Big - asymmetric - FS

wattage	colour	weight	CLD CELL		W tot	LUMEN OUTPUT (tq= 25 °C)	
			code			K - ølm - CRI	
16 LED	graphite grey 9006	7.50	413070-00		134	4000K - 12169lm - CRI 80	
			413074-00				

1724 Cripto Big - asymmetric - FL

wattage	colour	weight	CLD CELL		W tot	LUMEN OUTPUT (tq= 25 °C)	
			code			K - ølm - CRI	
16 LED	graphite grey 9006	7.50	413080-00		134	4000K - 12682lm - CRI 80	
			413084-00				

1725 Cripto Big - symmetric

wattage	colour	weight	CLD CELL		W tot	LUMEN OUTPUT (tq= 25 °C)	
			code			K - ølm - CRI	
16 LED	graphite grey 9006	7.50	413090-00		134	4000K - 12988lm - CRI 80	
			413094-00				



IP66IK08

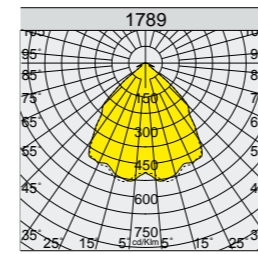
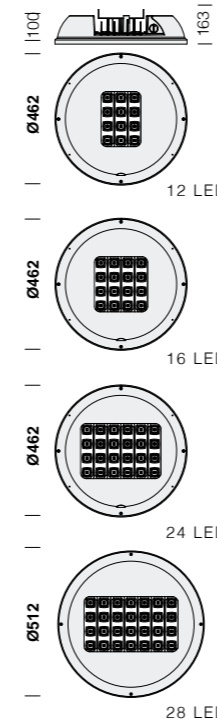

Optics: in high-performance metallic V0 polycarbonate with micro-faceted finish.

Emergency version: acc. 1175 (997651-00) to be purchased separately.

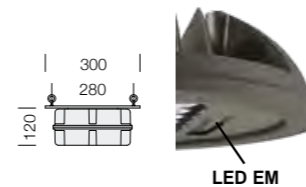

acc. 1175 EM box
997651-00

To be used when purchasing Astro EM version, with sub-code -07.



Ø462



Ø512



101W - 135W - 203W - 251W
=6/8kV

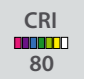
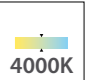
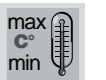

1789 Astro - UGR<25 - wide beam

		CLD CELL			LUMEN OUTPUT (tq= 25 °C)	
wattage	colour	weight	Ø	code	W tot	K - ølm - CRI
12 LED	grey	9.00	462	330096-00	101	4000K - 11149lm - CRI 80
	graphite			330097-00		
16 LED	grey	9.00	462	330090-00	135	4000K - 14865lm - CRI 80
	graphite			330093-00		
24 LED	grey	10.20	462	330091-00	203	4000K - 22298lm - CRI 80
	graphite			330094-00		
28 LED	grey	10.50	512	330092-00	235	4000K - 26013lm - CRI 80
	graphite			330095-00		
		CLD CELL-E			LUMEN OUTPUT (tq= 25 °C)	
wattage	colour	weight	Ø	code	W tot	K - ølm - CRI
12 LED	grey	9.00	462	330096-07	101	4000K - 11149lm - CRI 80
	graphite			330097-07		
16 LED	grey	9.00	462	330090-07	135	4000K - 14865lm - CRI 80
	graphite			330093-07		
24 LED	grey	10.20	462	330091-07	203	4000K - 22298lm - CRI 80
	graphite			330094-07		
28 LED	grey	10.50	512	330092-07	235	4000K - 26013lm - CRI 80
	graphite			330095-07		
		CLD CELLD-D (DALI)			LUMEN OUTPUT (tq= 25 °C)	
wattage	colour	weight	Ø	code	W tot	K - ølm - CRI
12 LED	grey	9.00	462	330096-0041	101	4000K - 11149lm - CRI 80
	graphite			330097-0041		
16 LED	grey	9.00	462	330090-0041	135	4000K - 14865lm - CRI 80
	graphite			330093-0041		
24 LED	grey	10.20	462	330091-0041	203	4000K - 22298lm - CRI 80
	graphite			330094-0041		
28 LED	grey	10.50	512	330092-0041	235	4000K - 26013lm - CRI 80
	graphite			330095-0041		

Luminous flux maintenance Power factor ≥0.95		Wattage (tot.)	Allowed ambient temperature (min.°C ÷ max.°C)
90%	100.000h (L90B10)	101W	Ta = -40°C ÷ +45°C
		135W	Ta = -40°C ÷ +45°C
		203W	Ta = -40°C ÷ +40°C
		235W	Ta = -40°C ÷ +40°C

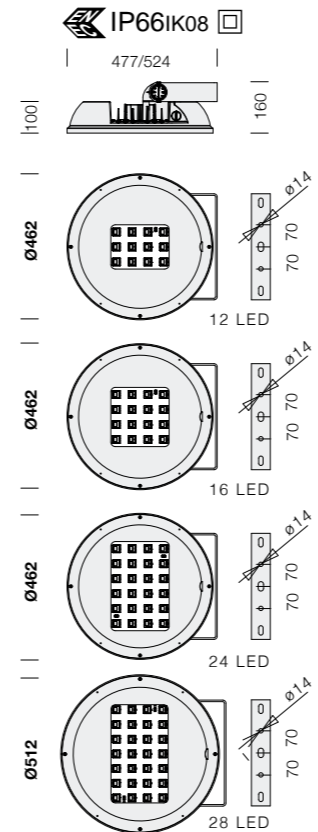
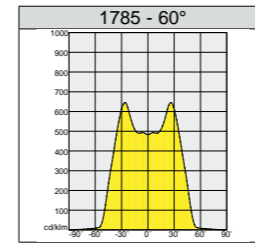
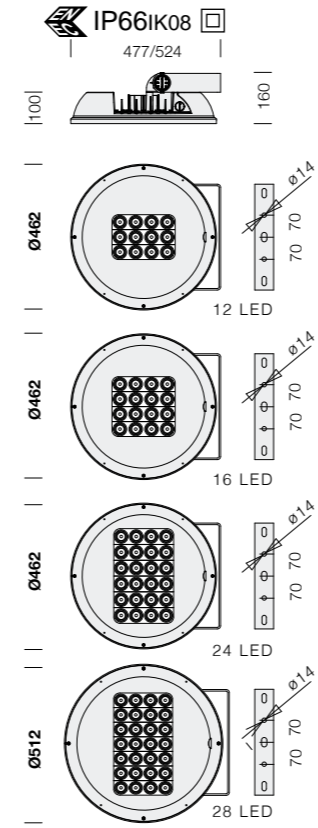

1785 Astro - symmetric 60°

wattage	colour	weight	Ø	CLD CELL		W tot	LUMEN OUTPUT (tq= 25 °C)	
				code	K - ølm 700mA - CRI - degrees			
12 LED	grey	12.25	462	330059-00	101	4000K - 11068lm - CRI 70 - 60°		
	graphite			330058-00				
16 LED	grey	12.25	462	330054-00	137	4000K - 14758lm - CRI 70 - 60°		
	graphite			330055-00				
24 LED	grey	13.80	462	330050-00	202	4000K - 23244lm - CRI 70 - 60°		
	graphite			330052-00				
28 LED	grey	14.00	512	330051-00	235	4000K - 26357lm - CRI 70 - 60°		
	graphite			330053-00				

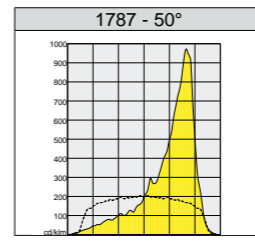

1787 Astro - asymmetric 50°

wattage	colour	weight	Ø	CLD CELL		W tot	LUMEN OUTPUT (tq= 25 °C)	
				code	K - ølm 700mA - CRI - degrees			
12 LED	grey	12.25	462	330079-00	101	4000K - 9732lm - CRI 70 - 50°		
	graphite			330078-00				
16 LED	grey	12.25	462	330074-00	137	4000K - 12976lm - CRI 70 - 50°		
	graphite			330075-00				
24 LED	grey	13.80	462	330070-00	202	4000K - 20438lm - CRI 70 - 50°		
	graphite			330072-00				
28 LED	grey	14.00	512	330071-00	235	4000K - 25953lm - CRI 70 - 50°		
	graphite			330073-00				

LOW
101W - 202W =4%
137W - 235W =<1%
FLICKER

101W - 137W
202W - 235W
=6/8kV
SURGE

RG0
E_{tr}

+40
C°
-30

100.000h
L90B10

4000K

CRI
70

LOW
101W - 202W =4%
137W - 235W =<1%
FLICKER

101W - 137W
202W - 235W
=6/8kV
SURGE

RG0
E_{tr}

+40
C°
-30

100.000h
L90B10

4000K

CRI
70



IP66IK08 Registered Design DM/100271

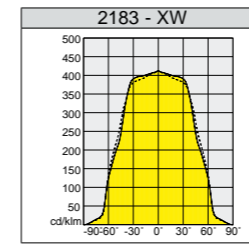
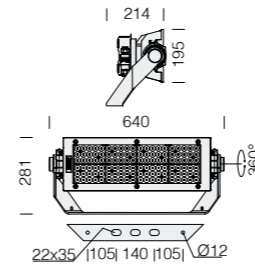

256W - 397W
457W=>8%
LOW FLICKER

256W=4/6kV
397W=10/10V
457W=6/6kV
SURGE

RG0
E_{th}

+40
C°
-30

4000K

CRI
70

2183 Forum - 1 LED MODULE - symmetric - "XW"

wattage (700mA)	colour	weight	code	W tot	LUMEN OUTPUT (tq= 25 °C)	
					CLD CELL	LUMEN OUTPUT (tq= 25 °C)
120 LED	graphite	15.00	412630-00	256	K - ølm 700mA - CRI	4000K - 33841lm - CRI 70
wattage (1050mA)					K - ølm 1050mA - CRI	
120 LED	graphite	15.00	412631-00	397	K - ølm 1200mA - CRI	4000K - 45235lm - CRI 70
wattage (1200mA)					K - ølm 1200mA - CRI	
120 LED	graphite	15.00	412632-00	457	K - ølm 1200mA - CRI	4000K - 49992lm - CRI 70

IP66IK08 Registered Design DM/100271

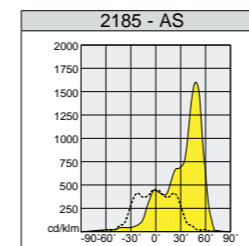
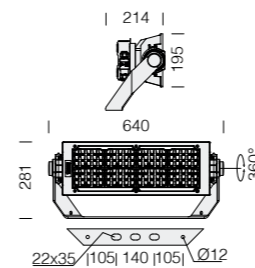

256W - 397W
457W=>8%
LOW FLICKER

256W=4/6kV
397W=10/10V
457W=6/6kV
SURGE

RG0
E_{th}

+40
C°
-30

4000K

CRI
70

2185 Forum - 1 LED MODULE - asymmetric - "AS"

wattage (700mA)	colour	weight	code	W tot	LUMEN OUTPUT (tq= 25 °C)	
					CLD CELL	LUMEN OUTPUT (tq= 25 °C)
120 LED	graphite	15.00	412650-00	256	K - ølm 700mA - CRI	4000K - 31178lm - CRI 70
wattage (1050mA)					K - ølm 1050mA - CRI	
120 LED	graphite	15.00	412651-00	397	K - ølm 1200mA - CRI	4000K - 41432lm - CRI 70
wattage (1200mA)					K - ølm 1200mA - CRI	
120 LED	graphite	15.00	412652-00	457	K - ølm 1200mA - CRI	4000K - 45552lm - CRI 70

LED: power factor ≥0,92.
Luminous flux maintenance:

70%	190.000h (L70B20)	700mA	80%	120.000h (L80B10)	700mA
70%	160.000h (L70B20)	1050mA	80%	100.000h (L80B10)	1050mA
70%	145.000h (L70B20)	1200mA	80%	90.000h (L80B10)	1200mA

Upon request available version with:

LED	4000K - CRI 80	700/1050/1200mA
LED	4000K - CRI 90	700/1050/1200mA
LED	5700K - CRI 70	700/1050/1200mA
LED	5700K - CRI 80	700/1050/1200mA
LED	5700K - CRI 90	700/1050/1200mA

Hydro Style

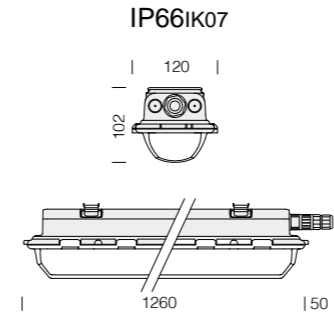

Special version, ideal for environments containing chemical substances, gas and vapours. The **body and the transparent screen** are in copolyester with a high level of light transmittance, capable of resisting to **chemical agents** (chlorine, ammonia, alkaline products, soapy detergents, alcohols, etc. See table for complete list).

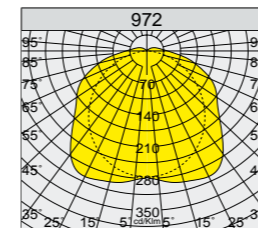

972 Hydro STYLE - LED

		CLD CELL		LUMEN OUTPUT (tq= 25 °C)	
wattage	colour	weight	code	W tot	K - ølm - CRI
LED	transparent	1,80	164790-00	31	4000K - 5547lm - CRI≥80
			164791-00	47	4000K - 7766lm - CRI≥80



Chemical	Appearance
Acetic acid (5%)	A
Acetone	I
Ammonium hydroxide (sp. gr. 0.90)	A
Ammonium hydroxide (10%)	A
Blasocut Kombi (5% in water)	A
Castrol SYNTILO 9913 (5% in water)	A
Detergent solution (0.025%)	A
Diesel Fuel	A
Dimethyl formamide	I
Distilled water	A
Ethanolamine (5%)	A
Ethyl alcohol (50%)	A
Ethyl alcohol (95%)	A
Hydrochloric acid 10%	A
Isopropanol	A
Lipid solution (2%)	A
Methyl alcohol	A
Olive oil	A
Soap solution (1%)	A
Sodium hypochlorite (5%)	A
Sodium chloride solution (10%)	A
Sodium hydroxide solution (10%)	A
Sulfuric acid 10%	A
Toluene	I

CODE	Comment
A	resistant
I	non resistant



disano 
illuminazione

DISANO ILLUMINAZIONE s.p.a.
 20089 Rozzano (MI)
 v.le Lombardia, 129
 centralino 02824771 (20 linee passanti)
 telefax 028252355
 Email: info@disano.it
 web: www.disano.it



www.disano.it

