

**LEDsmart+ Rotary Dimmer MMDM/RT**

**PRODUCT SUMMARY AND CAPABILITIES**

Designed in Australia to provide optimised dimming of LED based lamps and drivers, this high quality, two-wire phase control dimmer can be connected in parallel to other LEDsmart+ devices to provide a simple solution to multi-way control.

Although optimised for LED lighting loads, the dimmer also provides excellent compatibility with other common lamp types such as incandescent lamps, 12V halogen (dichroic) lamps and dimmable CFL's.

**PRODUCT FEATURES**

- Rotary Dimmer with built in on / off switch and multi-way control
- Suitable for one-way, two-way, three-way and multi-way dimming
- MultiMate™ technology allows multi-way dimming / switching with no extra wires
- Suitable for both retrofit and new installations
- Programmable minimum level, maximum level, kick-start, off state indicator, stepped dimming mode and more
- Active only 'two wire' connection - no neutral required
- No separate switch required - built in switch
- 'Quick flick' dim to maximum or minimum dimming level
- Illuminated halo with interchangeable coloured rings (blue/green/orange/clear)
- Dim to OFF with most LED light sources
- Kid's bedroom mode – double tap when on to dim down over 30 minutes
- Wake up mode – double tap when off to dim up over 30 minutes
- Selectable fall-back LED Indicator level
- 1W minimum load



Patented  
Registered Design



Designed in Australia to meet Australian Standards and installation conditions



**PROGRAMMABLE SETUP FUNCTIONS**

Minimum Brightness	If an LED or CFL lamp becomes unstable at low dimming levels, it can flicker or pulse on/off. The dimmer's minimum brightness can be set to a level above the point at which a lamp flickers/pulses.
Maximum Brightness	The maximum brightness level provided by the dimmer can be set to suit customer requirements.
Kick Start	This function is only required when dimming CFL lamps. To ensure these lamps switch on, they require the dimmer output to be set to 50% for 0.2 seconds when the lamp is turned on. A very small number of LED lamps may also benefit from this feature. <b>Default: The Kick Start feature is disabled.</b>
LED indicators	The dimmer's white LED indicators can be set to glow on or turn off when the dimmer is switched off. <b>Default: The white LED indicators are set to glow on when the dimmer is turned off.</b>
Separate Switch Mode	Some lamps, such as non-dimmable CFL's, can flicker when switched OFF using the dimmer's integrated switch. In these cases, the dimmer can be used in 'Separate Switch Mode' and combined with a separate mechanical switch. This mode is only recommended for single MultiMate installations. <b>Default: Separate Switch Mode is disabled.</b>
Toggle / Memory Dimmer	The dimmer has the option to turn on at the brightness level set when the lights were turned off (memory dimmer), or to turn on at the maximum brightness level (toggle dimmer). <b>Default: the dimmer is setup as a toggle dimmer.</b>
MultiMate™ ON/OFF	MultiMate™ functions can be switched ON or OFF. <b>Default: MultiMate™ features are switched ON.</b>
3 Step Dim Mode	The dimmer has the option to step through a sequence of brightness levels from Off -> Low -> Med -> High -> Off with each click of the dial. This replaces push-and-hold dimming operations on the dimmer dial. <b>Default: 3 Step Dim mode is switched OFF.</b>
CLM Mode	If dimming difficulty or dimmer behaviour issues are experienced, the dimmer can optionally be put into CLM Mode. This enables the dimmer to work with more difficult lamp types or in the presence of poor-quality mains supply. <b>Default: CLM mode is switched OFF.</b>

A wide range of LED and CFL lamps are available from different manufacturers. The following issues are occasionally seen when used in conjunction with 2-wire dimmer/timer/switch products:



- When switched off, the LED/CFL lights flicker, pulse on/off or do not switch off completely.
  - When switched off, the LEDsmart+ LED indicators flicker.
  - When switching on, the LED/CFL lights have difficulty switch on and the dimmer indicators flicker or pulse.
- If these are experienced: Install a LEDsmart+ Load bypass device (item code MMBP) across the lamp Line and Neutral terminals to provide improved system performance.

## MULTIMATE™ TECHNOLOGY

MultiMate™ is a technology inside the range of high quality LEDsmart+ dimmers, sensors, timers and electronic light switches. It allows multi-way control of lighting without the need for an expensive control system. MultiMate™ technology is suitable for both new and retrofit installations.

MultiMate™ technology enables multiple LEDsmart+ two-wire devices to be wired in parallel when two-way, three-way or multi-way dimming and switching is required.

When connected in parallel, LEDsmart+ dimmers, timers and occupancy sensors allow dimming (and switching) of connected lighting loads from multiple locations without any additional wiring. No strapper wires, dedicated remote switch wiring or control bus is required.

MultiMate™ is a patented technology, developed in Australia by Pierlite and Ozuno.

The wiring example shows two LEDsmart+ dimmers connected in parallel with a LEDsmart+ Occupancy Sensor. Together these provide user-controlled two-way dimming with Occupancy Sensor ON or OFF functions on four downlights without any additional wiring.

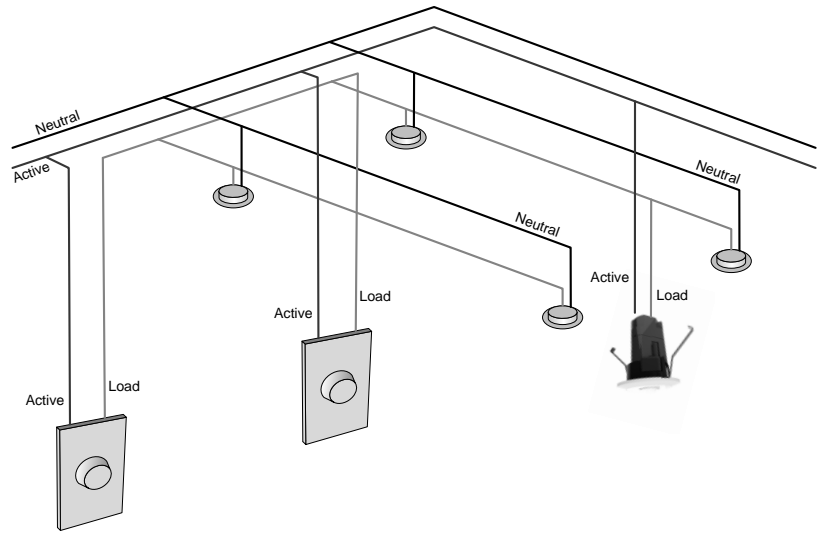

## PRODUCTS WITH MULTIMATE™ TECHNOLOGY INCLUDED

MultiMate™ technology is included in the following products. They can all be connected in parallel to allow multi-way control. *Note that different types of MultiMate™ products can be connected in parallel.*

For example: dimmers, motion sensors, switches and timers can be connected in parallel to control the same group of lights from different locations and/or provide additional functionality.

Item Code	Description	Features
MMDM/RT	LEDsmart+ Rotary Dimmer / Switch	Rotary Dimmer with built in on/off switch and multi-way control
MMDM/PB	LEDsmart+ Push Button Dimmer	Push Button Dimmer with built in on/off switch and multi-way control
MMSE/PR	LEDsmart+ 360° Occupancy Sensor	360° Occupancy Sensor programmable between 1 minute and 60 minutes with multi-way control
MMTM/PB	LEDsmart+ Push Button Minute Timer	Push Button Timer programmable between 1 minute and 30 minutes with multi-way control
MMTH/PB	LEDsmart+ Push Button Hour Timer	Push Button Timer programmable between ¼ hour and 7 ½ hours with multi-way control
MMSW/PB	LEDsmart+ Push Button Electronic Switch	Push Button Electronic Switch for LED lighting with built in on/off switch and multi-way control
MMDM/DD	LEDsmart+ Digital Level Display	Level Display for use with any dimmer
MMSR	LEDsmart+ Slave Relay	10A Relay for On/Off control from trailing edge dimming devices

## ROTARY / PUSH DIALS

Two different sizes of rotary/push dials are included. Either can be used depending on customer preferences. In general, the dials are used as follows:

Type	Best Suits
Smaller rotary dial	Wall plates with 2 or more gangs
Larger rotary dial	1-gang wall plates

## COLOURED INDICATOR RINGS

Out of the box, the large and small rotary/push dials are fitted with a clear silicon indicator ring. As the dimmer LED indicator is white, the clear silicon indicator ring provides a soft white glow when on.

Blue, green and orange silicon rings are also included with the dimmer. These can be used to match customer colour preferences, or to more easily identify different dimmers on the same grid plate.

## INSTALLING LEDSMART+ DEVICES INTO CLIPSAL SATURN™ OR CLIPSAL SATURN ZEN™ WALL PLATES

Adaptor kits are available separately to enable LEDsmart+ devices to be installed into Clipsal Saturn™ or Clipsal Saturn Zen™ wall plates. Order codes are as follows.

DGACCESSPK2	Adaptor kit for LEDsmart+ Push Button devices
DGACCESSPK3	Adaptor kit for LEDsmart+ Rotary dimmers

## WIRING DIAGRAMS

### ONE-WAY DIMMING AND SWITCHING

The dimmer has a built in push on / push off switch as well as a rotary dimmer. To provide both dimming and on/off control, no separate switch is required.

#### New installation: Dimming + Switching

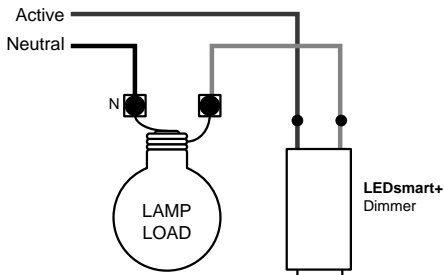

#### Existing Installation: Convert switching to switching + dimming

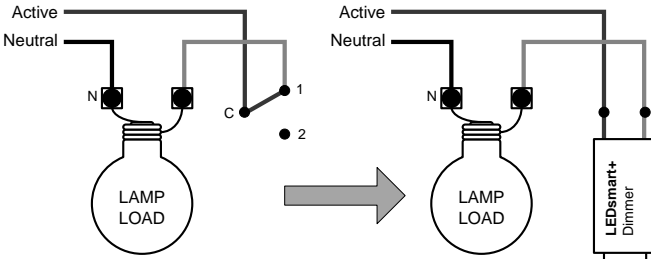

### TWO-WAY DIMMING AND SWITCHING

For two-way dimming and switching using LEDsmart+ dimmers, the two dimmers are connected in parallel.

Each LEDsmart+ dimmer has an integrated switch, so no separate switches or additional strappers are required for two way dimming and on/off control.

#### New installation: 2-way Dimming + Switching

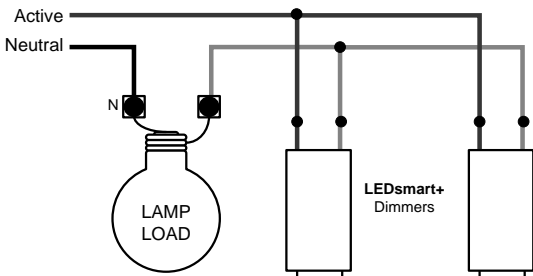

When replacing existing two-way switching with two-way dimming/switching using LEDsmart+, the existing two-way strapper wires can be re-used. No new wiring is required.

#### Existing installation: 2-way switching to switching + dimming

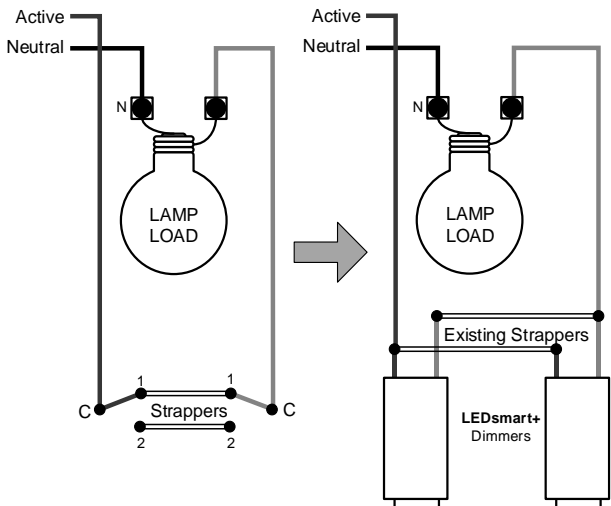

### MULTI-WAY (THREE-WAY OR MORE) DIMMING AND SWITCHING

For multi-way dimming and switching using LEDsmart+ dimmers, all dimmers are connected in parallel.

Each LEDsmart+ dimmer has an integrated switch, so no separate switches or additional strappers are required for multi-way dimming and on/off control.

The diagrams show the wiring for three-way dimming and switching using LEDsmart+ dimmers. If more than three-way control is required, further LEDsmart+ devices are simply wired in parallel.

#### New installation: 3-way or more way Dimming + Switching

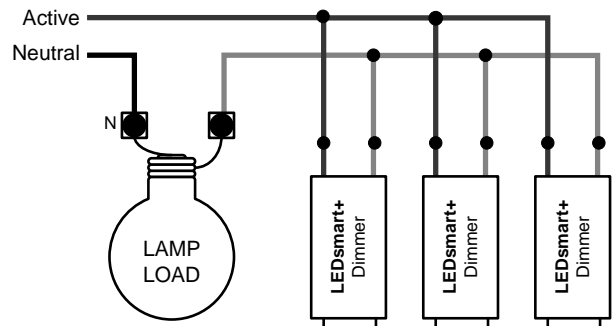

When replacing existing three or more way switching with multi-way dimming/switching using LEDsmart+, the existing strapper wires can be re-used. No new wiring is required.

#### Existing installation: 3-way switching to switching + dimming

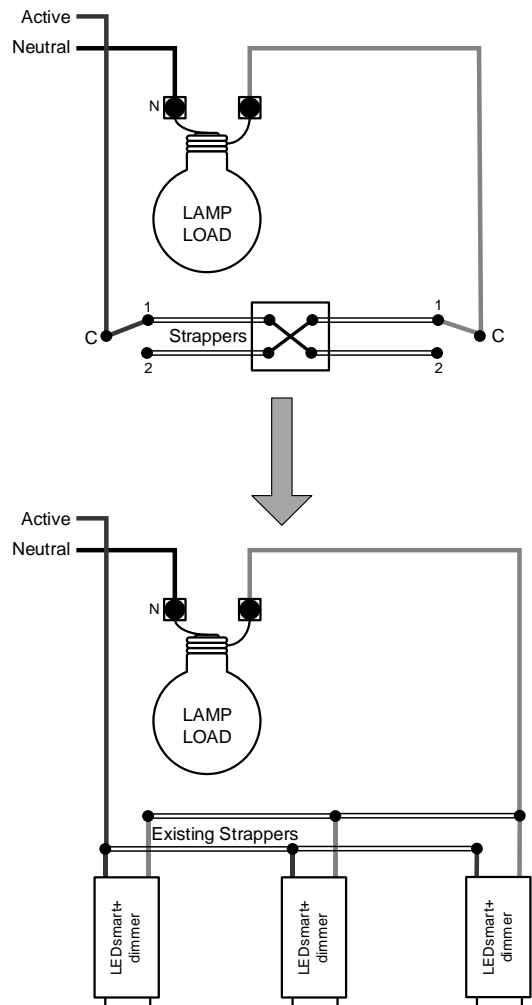







SPECIFICATIONS	
Nominal Line Voltage	220-240Vac
Line Frequency	50Hz Nominal (47 – 53Hz)
Load Brightness Control Range	0% to 100% (typical for LED loads)**
Rated Load	Refer Compatible Loads table (below)
Minimum Load	1W
Maximum cable distance between LEDsmart+ devices	50 m (when using existing strappers – per strapper segment) Example: a lighting load with 3 dimmers can have switches changed to dimmers, located 50 m apart, for a total end-end wiring length of 100 m.

\*\* Refer note on first page. An MMBP may be needed to prevent off-state LED glow in some cases.

### COMPATIBLE LOAD TYPES

The LEDsmart+ range are compatible with lighting loads that are designed for use with Phase Angle / Phase Cut dimmers.

Lighting loads that have not been designed for use with non-separately switched dimmers typically require the use of the MMBP Load Bypass device to achieve compatibility.

Load Symbol	Load Types	Max Load	Notes
	Dimmable LED Lamps	400W	The LED driver must be dimmable. Maximum permitted number of drivers is 400W divided by the driver nameplate power rating. Due to variety of LED lamp designs, maximum number of LED lamps is also dependent on power-factor result when connected to dimmer.
	Electronic Transformers	400W	
	Standard iron-core transformers	250W	Due to variety of transformer designs, max LV lighting load is also dependent on transformer efficiency.
	Toroidal iron-core transformers	300W	
	Incandescent	350W	
	Dimmable CFLs	400W	Due to the variety of CFL designs, the maximum number is make/model dependent.

### INCOMPATIBLE LOAD TYPES

Ceiling Sweep Fans and Exhaust fans.

Other non-lighting load types are generally not compatible. If control of a non-lighting load is required, consider using the MMSR Slave Relay accessory.

### MULTI-GANG DE-RATING

In applications where multiple dimmers are installed in a multi-gang plate, a de-rating factor is applied to the maximum load as follows.

Number of dimmers per plate	De-rating factor
1	No de-rating
2	0.85
3	0.7
4	0.55
5	0.4
6	0.25

**De-rating Example**  
Two LEDsmart+ devices installed in a wall plate. The maximum LED load which can be connected to each device =  $400W \times 0.85 = 340W$  per device.

### DIMMER INSTALLATION



This product must be installed by a suitably qualified installer who must work in accordance with standard safety procedures for mains-powered electrical equipment.

The terminal block included with the dimmer should be used to make the electrical connections as shown below.

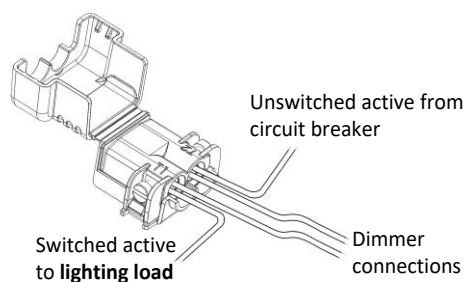

Once the connections have been made, the terminal cover is closed to ensure the screw terminals are not exposed

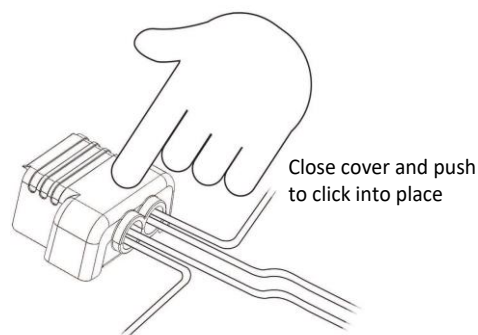

The terminal block can then be cable-tied to the rear of the dimmer housing utilising the two loop holes

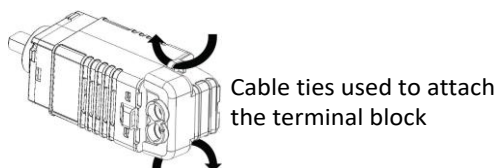

## DIMMER SETUP

The LEDsmart+ rotary dimmer has many useful functions which are set up by entering Setup and following the easy steps in this guide.

**MINIMUM BRIGHTNESS should always be set.** The other settings are optional, depending on the dimmer application.

All setup functions follow the same simple 4-step procedure, as shown in the diagram below.

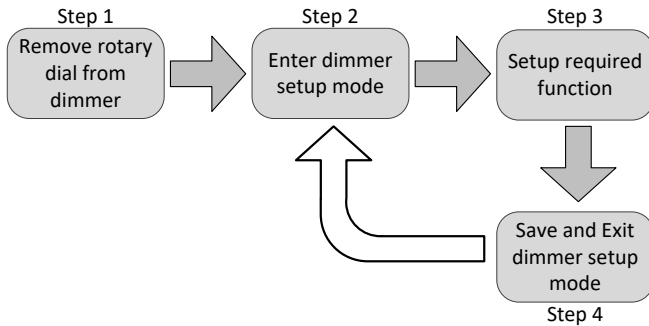

## SETTINGS ARE SHARED

When multiple LEDsmart+ Dimmers are used on the same controlled circuit, all useful setup properties are communicated and shared between them. For specialised applications this can be disabled.

## DIMMER SETUP FUNCTIONS

Function	See Part
Entering Setup Mode	A
Setting <b>Minimum Brightness</b>	B
Setting <b>Maximum Brightness</b>	C
Setting the <b>Kick Start</b> Feature	D
Setting <b>Off State LED</b> Feature	E
Setting <b>Separate Switch</b> Mode	F
Setting <b>Toggle / Memory</b> Dimmer	G
Setting <b>MultiMate™</b> Mode	H
Setting <b>3 Step Dim</b> Mode	I
Setting <b>CLM</b> Mode	J
<b>Factory Defaults Reset</b>	K



Once in Setup mode, options are selected by a series of clicks of the dimmer rotary shaft. Each click should be approximately 1 second after the previous click.

## A ENTERING SETUP MODE

Before starting to setup the dimmer, the rotary dial should be removed by pulling it off the shaft. This allows the white LED indicator to be easily seen during setup.

### Remove dial!

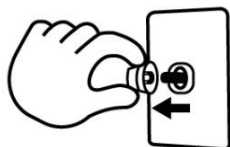

If the dimmer has been powered up for **LESS THAN 15 MINUTES**, see A1.

If the dimmer has been powered up for **MORE THAN 15 MINUTES**, see A2.

## A1: DIMMER HAS BEEN POWERED FROM MAINS FOR LESS THAN 15 MINUTES

1. Press and hold the dimmer rotary shaft for **10 seconds**.

*Connected lights will dim up or down, this is normal.*

**Press & Hold!**



2. The white LED Indicators will blink ON/OFF twice per second. This indicates that the dimmer is now in Setup Mode.

*If more than one LEDsmart+ device is connected in parallel, they all enter setup mode. The blink ON/OFF will also be seen on all other LEDsmart+ devices connected in parallel.*

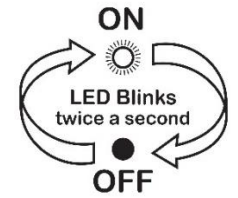

In the unlikely event that other LEDsmart+ devices connected in parallel do not enter setup, exit and try again.

3. The dimmer is ready for the settings to be adjusted as required. Go to the relevant setup function instructions.



## A2: DIMMER HAS BEEN POWERED FROM MAINS FOR MORE THAN 15 MINUTES

1. Press and hold the dimmer rotary shaft for **30 seconds**.

*This resets the Setup Entry time back to 10 seconds (for the next 15 minutes). Connected lights will dim up or down, this is normal.*

**Press & Hold!**



2. The white LED Indicators will blink ON/OFF twice per second. This indicates that the dimmer is now in Setup Mode.

*If more than one LEDsmart+ dimmer device is connected in parallel, they all enter setup mode. The blink ON/OFF will also be seen on all other LEDsmart+ devices connected in parallel.*

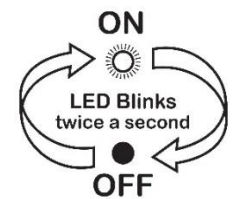

In the unlikely event that other LEDsmart+ devices connected in parallel do not enter setup, exit and try again.

3. The dimmer is ready for the settings to be adjusted as required. Go to the relevant setup function instructions.



## B: SETTING MINIMUM BRIGHTNESS

The Minimum Brightness level provided by the dimmer can be set to suit specific lamps and / or customer requirements. For most lamps, a minimum level as low as 0% can be set if required. However, some lamps (particularly CFLs) can become unstable at low dimming levels. If lamps become unstable at low dimming levels, they typically flicker or pulse on / off. The dimmer allows the minimum brightness to be set to a level above the point at which the lamp flickers / pulses.

1. Enter the dimmer **Setup Mode** - See **PART A**.

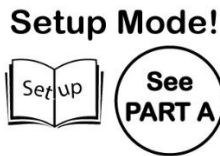

2. Click the dimmer rotary shaft **twice**.



3. The LED will blink 2 times.  
*If more than one dimmer is connected to the same load, they will all now blink 2 times.*

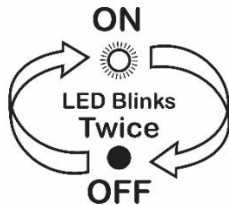

4. Adjust the dial until the lamp(s) are at the required **MINIMUM** brightness level.  
*If more than one dimmer is connected to the same load, wait for 3 seconds for the other dimmers to learn the new setting.*  
*To cancel/exit do nothing for 30 seconds.*



5. Click once to save & exit.  
*If more than one dimmer is connected to the same load, **the brightness levels only needs to be set in one dimmer.** The setting is automatically saved to all other dimmers.*



## C: SETTING MAXIMUM BRIGHTNESS

The maximum brightness level provided by the dimmer can be set to suit customer requirements. When lamps are dimmed near to full brightness, it is difficult to see changes in dimming level.

**Recommended process when setting maximum brightness:**  
Dim the lamp slowly up to a point where no further changes in brightness can be seen. Set the maximum level at this point.

### Setup Mode!

1. Enter the dimmer **Setup Mode** - See **PART A**.



2. Click the dimmer rotary shaft **3 times**.



3. LED will blink 3 times.  
*If more than one dimmer is connected to the same load, they will all now blink 3 times.*

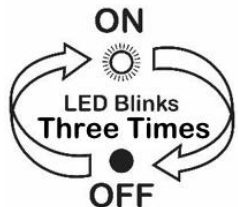

4. Adjust the dial until the lamp(s) are at the required maximum brightness level.  
*To cancel/exit do nothing for 30 seconds.*



5. Click once to save & exit.  
*If more than one dimmer is connected to the same load, **the brightness levels only needs to be set in one dimmer.** The setting is automatically saved to all other dimmers.*





## D: SETTING THE KICK START FEATURE

The 'kick-start' feature should only be enabled when dimming loads such as compact fluorescent lamps. These lamps need the dimmer output to be set to 50% for 0.2 of a second when the lamp is turned on. This ensures the lamp strikes successfully. The result is a short bright 'blink' when a compact fluorescent lamp turns on.

**As the bright blink caused by the kick start feature can be undesirable for the user, leave this feature disabled (the default) when using LED and other light sources which do not require the kick start to operate.**

By default, Kick Start Mode is **disabled**. To **enable** Kick Start Mode, follow the steps below.

1. Enter the dimmer **Setup Mode** – See **PART A**.



2. Click the dimmer rotary shaft **4 times**.



3. LED will blink 4 times.

If Kick start is **currently Disabled** (Default), lamp(s) connected to the dimmer will now turn **OFF**.

If Kick start is **currently Enabled**, lamp(s) connected to the dimmer will now turn **ON**.

*If more than one dimmer is connected to the same load, they will all now blink 4 times.*

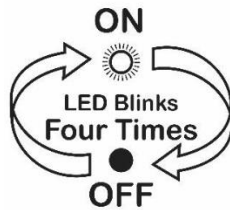

4. **To Enable Kick Start Mode** adjust the dial Clockwise until lamp(s) turn **ON**.

**To Disable Kick Start Mode** (Default) adjust dial Anti-Clockwise until lamp(s) turn **OFF**.

*To cancel/exit do nothing for 30 seconds.*



5. Click once to save & exit.

*If more than one dimmer is connected to the same load, **the kick start feature levels only needs to be set in one dimmer**. The setting is automatically saved to all other dimmers.*



## E: SETTING OFF STATE INDICATION

When the dimmer is switched off, the white LED indicators in the dimmer can be set to glow on or turn off.

By Default, the white LED indicators are set to glow on when the dimmer is turned off.

To set the LED indicators to turn off when the dimmer is off, follow the steps below.



1. Enter the dimmer **Setup Mode** – See **PART A**.

2. Click the dimmer rotary shaft **5 times**.



3. LED will blink 5 times.

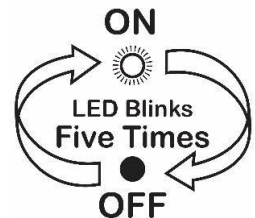

4. **To set Indicator to glow on when dimmer is off** (Default) adjust the dial Clockwise until the lamp(s) turns **ON**.

**To set Indicator to turn off when dimmer is off** adjust the dial Anti-Clockwise until the lamp(s) turns **OFF**.

*To cancel/exit do nothing for 30 seconds.*



5. Click once to save & exit.



## F: SETTING SEPARATE SWITCH MODE

The dimmer operates as a combined switch and dimmer, taking up only one gang in a wall plate.

Some lamps (for example, non-dimmable CFL's) can flicker when switched OFF by pressing the rotary button / dial. If this happens, the dimmer should be used in 'Separate Switch Mode' and combined with a standard mechanical switch. Note this also applies where two way switching operation is required.

These steps will set Separate Switch Mode and set the turn on level.

1. Enter the dimmer **Setup Mode** – See **PART A**.



2. Click the dimmer rotary shaft **six times**.



3. LED will blink 6 times.

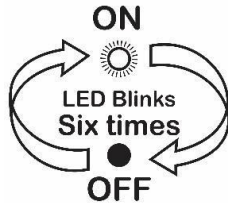

4. **To Enable Separate Switch Mode** adjust the dial Clockwise until the lamp(s) turn ON.

*The level the lamp(s) are adjusted to during this step will be the turn on level when the separate switch is used during normal operation.*

**To Disable Separate Switch Mode** (Default) adjust the dial Anti-clockwise until the lamp(s) turn OFF (or pulses ON/OFF).

*To cancel/exit do nothing for 30 seconds.*

**Adjust!**



5. Click once to save & exit.



6. Additional operation notes for Separate Switch Mode:

- a. If the MEMORY DIMMER function is disabled: Clicking the rotary button / dial will toggle between minimum and maximum level.
- b. If the MEMORY DIMMER function is enabled: Clicking the rotary button / dial will toggle between minimum level and previous level.
- c. LED indicators are OFF when the separate switch is off. This is regardless of whether the OFF STATE LED feature is used.
- d. When the separate switch is turned on, the lamp(s) will always turn on at the level set in step 4 above.
- e. The separate switch can comprise conventional switches with conventional 2-way wiring.
- f. For application such as hotel key-card:
  - Several MultiMate product can be wired in parallel after the power switch, so that multi-way control is possible after power up.
  - In that case, set SEPARATE SWITCH mode active only one dimmer, this will then set the power on level.



## G: SETTING TOGGLE / MEMORY DIMMER

The dimmer has the option to turn on at the brightness level set when the lights were turned off (memory dimmer), or to turn on at the maximum brightness level (toggle dimmer).

By default, the memory dimmer option is disabled so when the connected lights are off and the button / dial is tapped, the lights will turn on at maximum brightness. Alternatively, rotating the dial clockwise when the connected lights are off will dim the lights up from the minimum level.

### Setup Mode!

1. Enter the dimmer **Setup Mode** - See **PART A**.



2. Click the dimmer rotary shaft **7 times**.



3. LED will blink 7 times.

If the memory dimmer function is **currently Disabled**, lamp(s) connected to the dimmer will now turn **OFF**.

If the memory dimmer function is **currently Enabled**, lamps(s) connected to the dimmer will now turn **ON**.

*If more than one dimmer is connected to the same load, they will all now blink 7 times.*

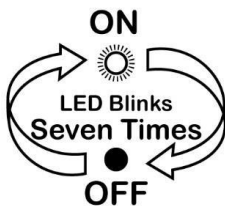

4. **To Enable the memory dimmer**, adjust the dial Clockwise until the lamp(s) turns ON.

**To Disable the memory dimmer** (Default) adjust the dial Anti-clockwise until the lamp(s) turns OFF.

*To cancel/exit do nothing for 30 seconds.*

### Adjust!



5. Click once to save & exit.

*If more than one dimmer is connected to the same load, the **Memory Dimmer option only needs to be set in one dimmer.***

*The setting is automatically saved to all other dimmers.*



## H: SETTING MULTIMATE™ DIMMER MODE

In some installations the MultiMate features are not required.

In very specific situations the MultiMate communication may interfere with the operation of other MultiMate devices in the installation. Any single-way dimmers can have MultiMate mode disabled in this situation.

***It is recommended to disable MultiMate mode when the dimmer is not wired in parallel with any other MultiMate devices.***

### Setup Mode!

1. Enter the dimmer **Setup Mode** - See **PART A**.



2. Click the dimmer rotary shaft **8 times**.



3. LED will blink 8 times.

If the MultiMate™ function is **currently Disabled**, lamp(s) connected to the dimmer will now turn **OFF**.

If the MultiMate™ function is **currently Enabled**, lamps(s) connected to the dimmer will now turn **ON**.

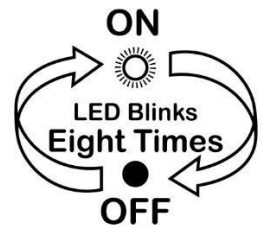

4. **To Enable MultiMate™** (Default) adjust the dial Clockwise until the lamp(s) turns ON.

**To Disable MultiMate™** adjust the dial Anti-clockwise until the lamp(s) turns OFF.

*To cancel/exit do nothing for 30 seconds.*

### Adjust!



5. Click once to save & exit.



## I: SETTING 3 STEP DIM MODE

The dimmer has the option to step through a sequence of brightness levels with each click of the button / dial. This replaces push-and-hold dimming operations on the dimmer button / dial.

### (Default) Normal behaviour:

Tap on dial:	Toggle on/off
Press and hold:	Fade brightness up/down

### 3-step dim enabled:

Tap on dial:	Cycle: Off -> Low -> Medium -> High -> Off (etc)
Press and hold:	Advance to the next step in the cycle

### Setup Mode!

1. Enter the dimmer **Setup Mode** - See **PART A**.



2. Click the dimmer rotary shaft **9 times**.



3. LED will blink 9 times.

If the 3 Step Dim function is **currently Disabled**, lamp(s) connected to the dimmer will now turn OFF.

If the 3 Step Dim function is **currently Enabled**, lamps(s) connected to the dimmer will now turn ON.



4. To **Enable 3 Step Dim** adjust the dial Clockwise until the lamp(s) turn ON.

To **Disable 3 Step Dim** (default) adjust the dial Anti-clockwise until the lamp(s) turn OFF.

To *cancel/exit do nothing for 30 seconds.*

### Adjust!



5. Click once to save & exit.



Additional operation notes for 3 Step Dim Mode:

- a. The dimmer Minimum Level is used for the Low level in the sequence (see Section B).
- b. The dimmer Maximum Level is used for the High level in the sequence (see Section C).
- c. The Medium level in the sequence is automatically selected as approximately half-way between the dimmer Minimum and Maximum levels.
- d. If the lamp(s) are On and the dial has not been touched for 15 seconds or more, a tap on the dial will turn lamp(s) Off.

## J: SETTING CLM MODE

The dimmer can optionally be put into CLM Mode. This can be helpful to overcome practical issues where the dimmer does not operate as expected, due to the characteristics of the lamp(s) used or due to issues of poor-quality mains power supply.

When operating in CLM Mode the dimmer changes its operation including the following:

- a. Internal functions allow for more difficult lamp types and poorer mains supply conditions.
- b. The white LED indicators only turn On at Maximum setting.
- c. The Off State LED is disabled.
- d. The Minimum Level is limited to the default value, no lower.

Because dimmer functionality is reduced when operating in CLM Mode, it is highly recommended that this feature remains disabled (the default) when using LEDs and other light sources which do not require CLM Mode for normal operation.

CLM Mode has a different Enable / Disable sequence to other functions:

### Setup Mode!

1. Enter the dimmer **Setup Mode** - See **PART A**.



2. To **ENABLE CLM Mode** press and hold the dimmer rotary shaft for at least 5 seconds.

This will toggle CLM Mode from Disabled to Enabled.

The dimmer will automatically save & exit from Setup.

If CLM Mode was successfully **enabled**, the dimmer's LED Indicators will be **OFF**.

### Press & Hold!



- To **DISABLE CLM Mode** (Default) press and hold the dimmer rotary shaft for at least 5 seconds.

This will toggle CLM Mode from Enabled to Disabled.

The dimmer will automatically save & exit from Setup.

If CLM Mode was successfully **disabled**, the dimmer's LED Indicators will be **ON**.

To *cancel/exit do nothing for 30 seconds.*

## K: RESETTING TO FACTORY DEFAULTS

1. Enter the dimmer **Setup Mode** - See **PART A**.



2. Click the dimmer rotary shaft **ten times**.



3. The dimmer will reset itself to default settings and automatically exit Setup Mode.

## OPTIONAL ADDITIONS TO A LEDSMART+ INSTALLATION

### LOAD BYPASS – MMBP

The MMBP load bypass is wired across the lighting load. It will resolve almost all issues associated with dimming of LED lighting, including:

- Lamp glow when turned off
- Flickering or pulsing of the lamp when turned off or to low dimming levels
- Flickering or pulsing of the dimmer LED indicators.

This product has a TWO YEAR warranty against manufacturing defects in addition to relevant consumer law guarantees. Refer to [pierlite.com](http://pierlite.com) for our full warranty conditions, or phone customer service.

Clipsal Saturn™ and Clipsal Saturn Zen™ are trademarks of Schneider Electric (Australia) Pty Ltd

#### © Copyright

This user and installation guide is copyright to Signify Innovations Australia Pty Ltd. Except as permitted under relevant law, no part of this user and installation guide may be reproduced by any process without written permission of and acknowledgement to Signify Innovations Australia Pty Ltd.

Signify Innovations Australia Pty Ltd reserves the right to alter the specifications, designs or other features of any items and to discontinue any items at any time without notice and without liability. While every effort is made to ensure that all information in this user and installation guide is correct, no warranty of accuracy is given and Signify Innovations Australia Pty Ltd shall not be liable for any error.

DIGINET and PIERLITE are brands of Signify Innovations Australia Pty Ltd (ABN 74 619 622 196). 96-112 Gow Street, Padstow NSW 2211, Australia.

DIGINET and PIERLITE are brands of Signify New Zealand Limited. 686A Rosebank Road, Avondale, Auckland 1026, New Zealand.

Customer Service: AU: 1300 799 300 | NZ 0508 743 754  
International: +61 2 9353 9417

[www.pierlite.com](http://www.pierlite.com)